

WEO[®] BARDAGE COMPOSITE CO-EXTRUDÉ

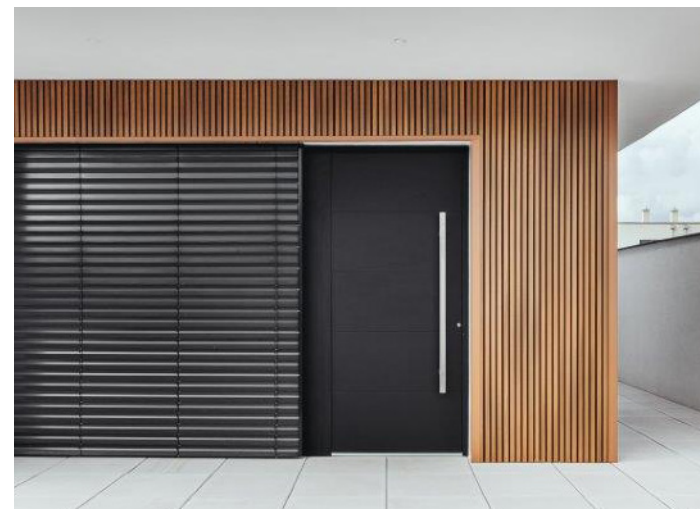

Fiberdeck[®]



WEO®

Fiberdeck®

Bardage biosourcé aux performances inégalées

Les lames de bardage WEO® ont été développées avec les dernières technologies de co-extrusion pour garantir un produit sans décoloration pendant 20 ans, tout en utilisant 95% de déchets dans sa fabrication. Un film de polyéthylène étanche protège le bois de toute reprise d'humidité et stabilise le matériau. La dilatation est aussi réduite à son minimum.



The mark of responsible forestry

95%
DE DÉCHETS RECYCLÉS
RECYCLABLES !

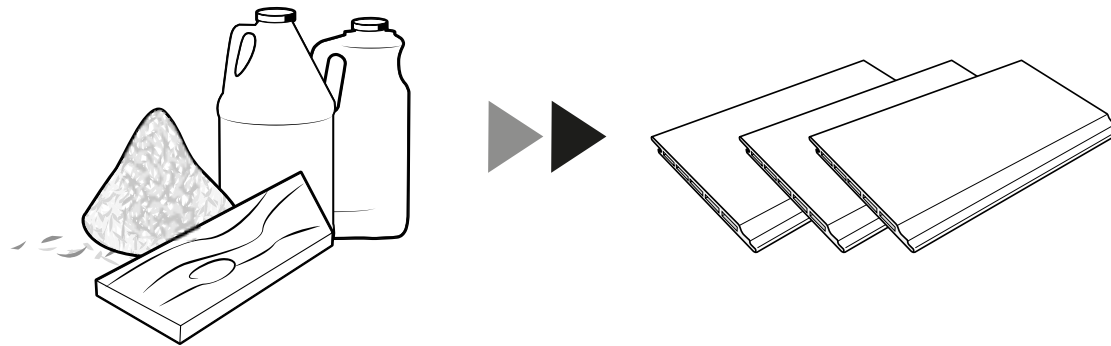

Fabriquées à partir de 95% de déchets, les lames WEO®
sont elles-mêmes 100% recyclables

Fiberdeck®



Un bois garanti sans tache et sans décoloration

Avec 10 ans d'expérience et plusieurs millions de mètres carrés commercialisés à ce jour sous des climats les plus variés, nous pouvons garantir nos produits 20 ans sans aucune décoloration visible à l'œil.



Des décors uniques et des couleurs saisissantes

Nos lames co-extrudées procurent une émotion unique à vivre pour une expérience exclusive. Les qualités techniques et esthétiques sont un gage de sérénité pour l'utilisateur.

D'un aspect mat, les couleurs des lames sont intenses et multi-chromatiques. Aucune lame n'est identique, le process de fabrication permet de restituer des teintes variées aléatoires. Les projets ainsi réalisés se fondent harmonieusement dans leur environnement.



WEO[®] Classic

P. 08



WEO[®] 35

P. 10



WEO[®]
60

P. 12



WEO[®]
Brise-soleil

P. 14

WEO® Classic



UV RESIST



20 YEARS
WARRANTY
Limited Residential



UN BARDAGE BOIS AUX COULEURS INTENSES ET LUMINEUSES !

Les lames de bardages WEO® Classic sont proposées dans 4 teintes multichromatiques garanties sans décoloration. Elles donnent un éclat unique à votre façade. La surface brossée et mate imite au mieux le bois naturel pour une durée sans égale.



LAME BARDAGE WEO® CLASSIC

13 x 173 mm x 3.6 M



Teak
FD1082



Ipé
FD1083



Light Grey
FD1084



Dark Grey
FD1085



PROFIL DE DÉPART U ALUMINIUM (2 PCS)

25 x 0,7 mm x 3 m

FD1090



PROFIL F ALUMINIUM (2 PCS)

35 x 45 mm x 3,60 m | 3,24 kg (pce)

FD1086 | ■ Teak

FD1088 | ■ Light Grey

FD1087 | ■ Ipé

FD1089 | ■ Dark Grey



CLIP INOX WEO® CLASSIC 100 PCS + VIS

1,2 kg (pce) | 9 m²

FD1091



VIS INOX BARDAGE WEO CLASSIC 100 PCS

Pour pose verticale | 20 m²

FD1313 | ■ Teak

FD1315 | ■ Light Grey

FD1314 | ■ Ipé

FD1316 | ■ Dark Grey

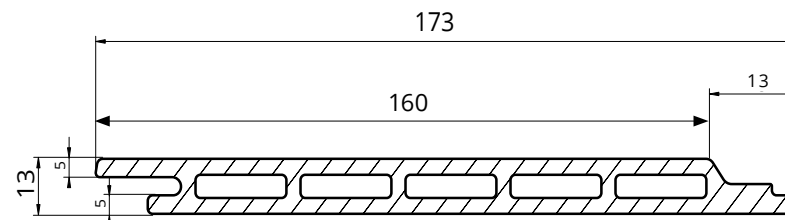

Surface d'une lame (utile)	0,576m ²
Masse surfacique	10,3 kg/m ²
Largeur hors tout	173 mm
Largeur utile	162 mm
Longueur standard	3600 mm

WEO® 35



UN PROFIL À FAUX CLAIRE-VOIE CONTEMPORAIN

Les lames à faux-claire-voie WEO® 35 offrent une durabilité inégalée. Elles habillent votre façade d'un parement chic et moderne, de teintes bois mat sans aucune décoloration et sans entretien.



LAME BARDAGE WEO® 35

33x170mm x 2.9m | 33x170mm x 3.9m



Cedar
2.9M FD1544
3.9M FD1548



Teak
2.9M FD1541
3.9M FD1545



Ipé
2.9M FD1542
3.9M FD1546



Dark Grey
2.9M FD1543
3.9M FD1547



PROFIL F ALUMINIUM (2 PCS)

65 x 80 mm x 3,60 m

FD1428 | Cedar
FD0967 | Teak

FD0968 | Ipé
FD0970 | Dark Grey

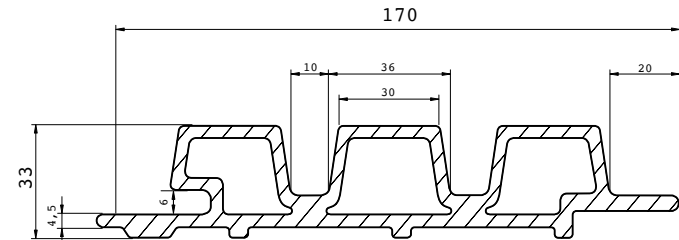

VIS INOX SR2 BOITE DE 100 PCS + EMBOUT

4,2 x 38 mm | 4,00 kg (pce) | 6 m²

FD1451 | Cedar
FD1447 | Teak

FD1448 | Ipé
FD1450 | Dark Grey

	Longueur 2.9M	Longueur 3.9M
Surface d'une lame (utile)	0,406 m ²	0,546 m ²
Masse surfacique	15 kg/m ²	15 kg/m ²
Largeur hors tout	170 mm	170 mm
Largeur utile	140 mm	140 mm

WEO® 60



UN ASPECT À FAUX CLAIRE-VOIE DES PLUS MODERNE

Le bardage WEO® 60 avec son profil à faux claire-voie permet de le poser rapidement à l'horizontal ou à la vertical. Les lamelles de 60mm de large sont régulièrement espacées d'un jour de 10mm. Les lames sont légères et faciles à installer, mais aussi très stables avec notre système de fixation. Il est possible de mixer les profils WEO® 35 et WEO® 60 pour donner du rythme à la façade, comme également l'associer à d'autres matériaux modernes pour le plus bel effet.



LAME BARDAGE WEO® 60
33x170mm x 2.9m | 33x170mm x 3.9m



Cedar 2.9M FD1567 3.9M FD1571	Teak 2.9M FD1565 3.9M FD1569	Ipé 2.9M FD1566 3.9M FD1570	Dark Grey 2.9M FD1568 3.9M FD1572
--	---	--	--



PROFIL F ALUMINIUM (2 PCS)
65 x 80 mm x 3,60 m

FD1428 Cedar	FD0968 Ipé
FD0967 Teak	FD0970 Dark Grey



VIS INOX SR2 BOITE DE 100 PCS
+ EMBOUT
4,2 x 38 mm | 4,00 kg (pce) | 6 m²

FD1451 Cedar	FD1448 Ipé
FD1447 Teak	FD1450 Dark Grey



VIS INOX BARDAGE WEO® 60
POUR POSE INVISIBLE
4.2x32mm | 500pcs + embout
FD1337

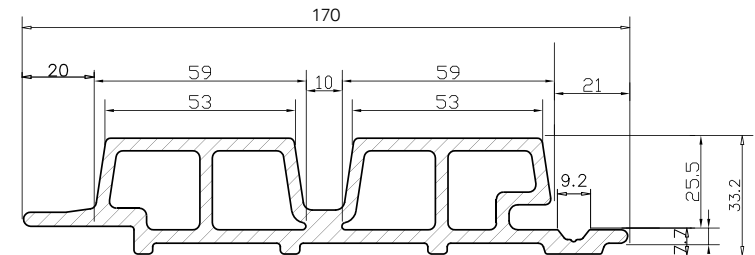

	Longueur 2.9M	Longueur 3.9M
Surface d'une lame (utile)	0,406 m²	0,546 m²
Masse surfacique	14,5 kg/m²	14,5 kg/m²
Largeur hors tout	170 mm	170 mm
Largeur utile	140 mm	140 mm

WEO® Brise-soleil



UV RESIST



UN JEU DE LAMES BOIS POUR SE PROTÉGER DU SOLEIL !

Les brises soleil en bois composite offrent une protection efficace aux rayons du soleil. En jouant sur leur espacement, ils permettent des jeux d'ombres sur la façade et isolent de la chaleur. Un décor bois contemporain unique, sans aucun vieillissement.

Fiberdeck®



Teak



Ipé



BRISE-SOLEIL

42 x 60 mm x 4 m
52 x 100 mm x 4 m
62 x 120 mm x 4 m

Teak
FD1092
FD1094
FD1096

Ipé
FD1093
FD1095
FD1097



CAPUCHON

42 x 60 mm (x24)
52 x 100 mm (x10)
62 x 120 mm (x6)

Teak
FD1098
FD1100
FD1102

Ipé
FD1099
FD1101
FD1103



1 AGRAFE ALU NV3 ajustable
FD1154

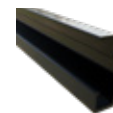
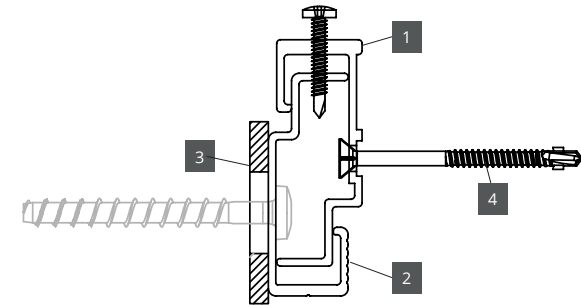

2 RAIL KX-3000 RAL9005
FD1156



3 CALE rupture de pont thermique
FD1157



4 VIS INOX A2 autoperçuse
5,5 x 32 mm FD1155 5,5 x 50 mm FD1223
5,5 x 38 mm FD1222 5,5 x 60 mm FD1224

WEO® Classic

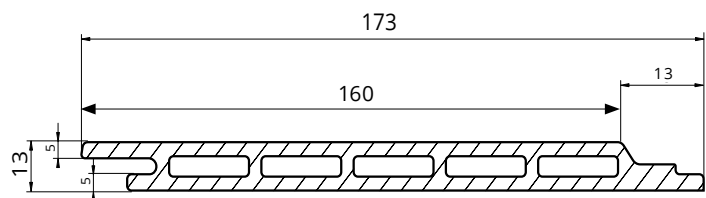

Surface d'une lame (utile)	0,576m ²	
Masse surfacique	10,3 kg/m ²	
Largeur hors tout	173 mm	
Largeur utile	162 mm	
Longueur standard	3600 mm	
	Nb de clips /m ²	Nb de clips / lame de 3,6 m
Entraxe 600 mm	11	7

WEO® 35

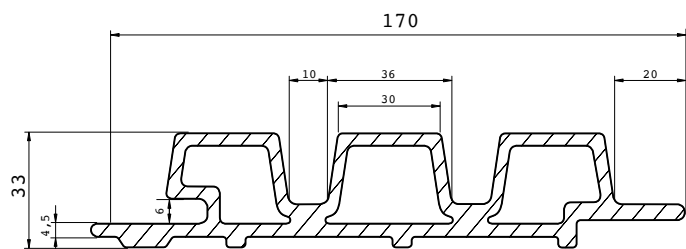

Longueur standard	2900 mm	3900 mm
Surface d'une lame (utile)	0,406 m ²	0,546 m ²
Masse surfacique	15 kg/m ²	15 kg/m ²
Largeur hors tout	170 mm	170 mm
Largeur utile	140 mm	140 mm
Nb de vis / m ² (entraxe 600 mm)	12	12
Nb de vis / lame (entraxe 600 mm)	5	7

WEO® 60

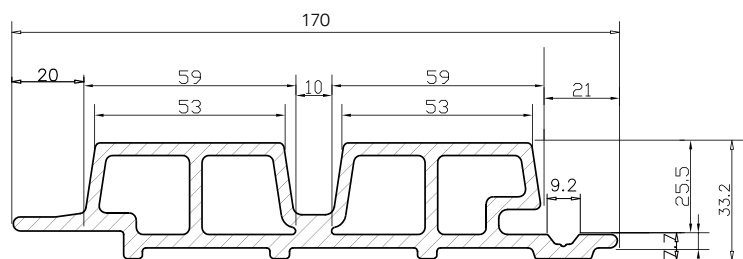

Longueur standard	2900 mm	3900 mm
Surface d'une lame (utile)	0,406 m ²	0,546 m ²
Masse surfacique	14,5 kg/m ²	14,5 kg/m ²
Largeur hors tout	170 mm	170 mm
Largeur utile	140 mm	140 mm
Nb de vis / m ² (entraxe 600 mm)	12	12
Nb de vis / lame (entraxe 600 mm)	5	7

WEO® Brise-Soleil

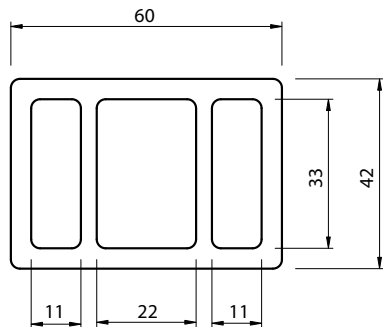

Poids / Mètre linéaire	1,75 kg
Largeur hors tout	60 mm
Hauteur hors tout	42 mm
Longueur standard	4 m

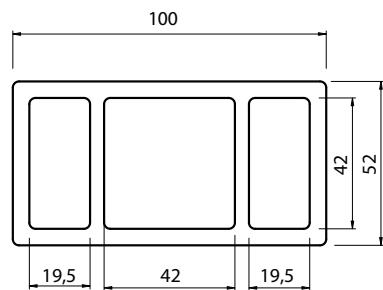

Poids / Mètre linéaire	3 kg
Largeur hors tout	100 mm
Hauteur hors tout	52 mm
Longueur standard	4 m

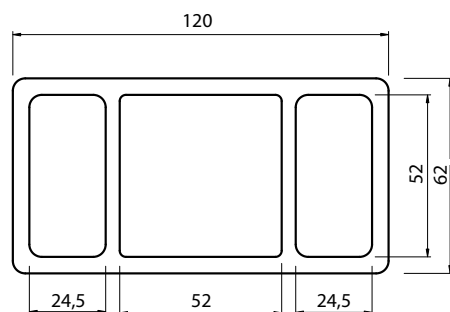

Poids / Mètre linéaire	3,70 kg
Largeur hors tout	120 mm
Hauteur hors tout	62 mm
Longueur standard	4 m

WEO® Classic

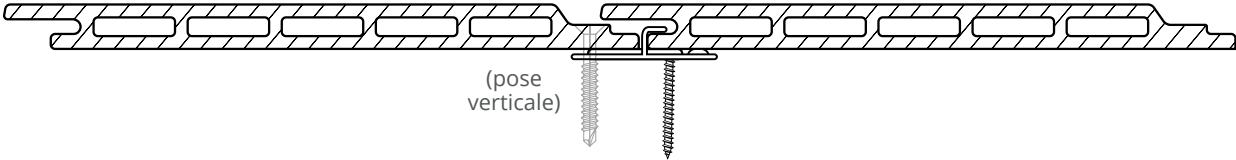

FIXATION PAR CLIP

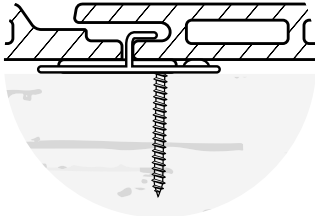

WEO® 35

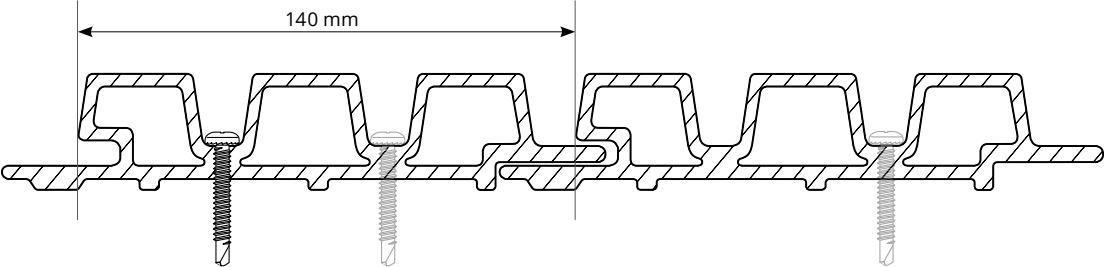

FIXATION PAR VIS

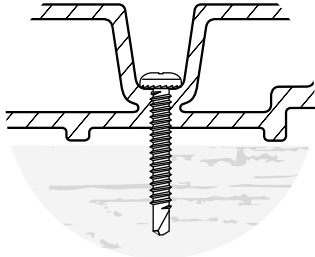

WEO® 60

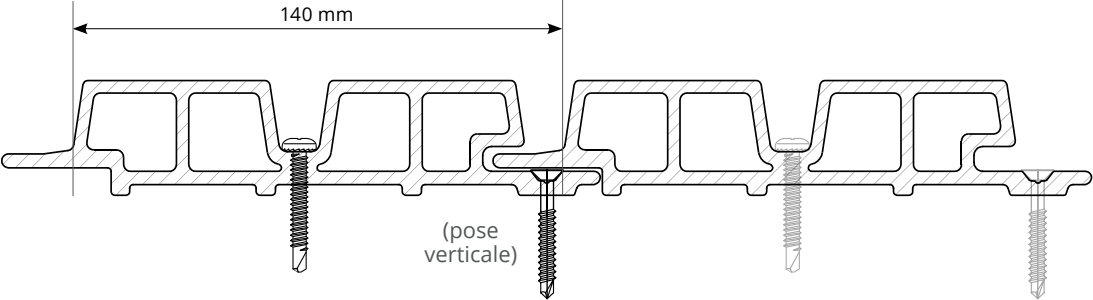

FIXATION PAR VIS

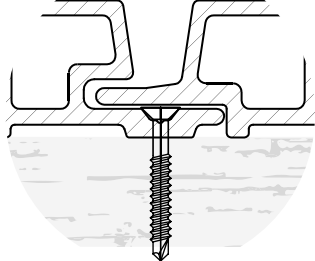

WEO® Brise-Soleil

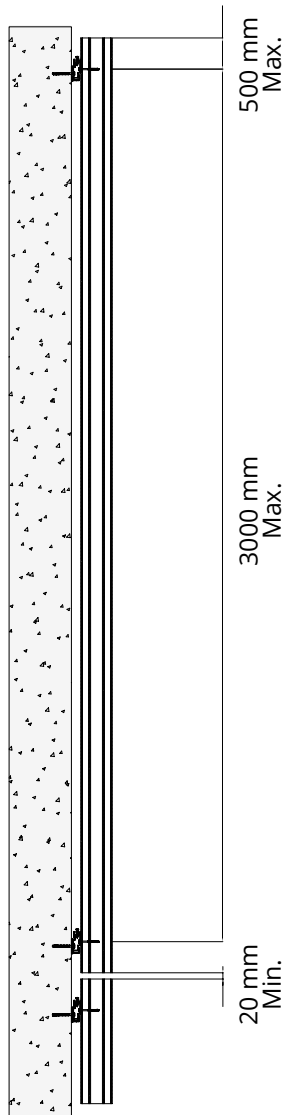

FIXATION PAR AGRAFE SUR RAIL

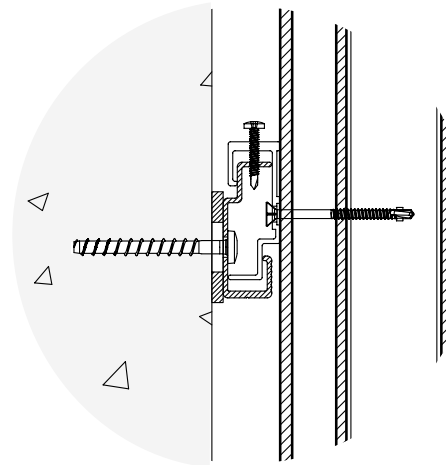

POSE VERTICALE

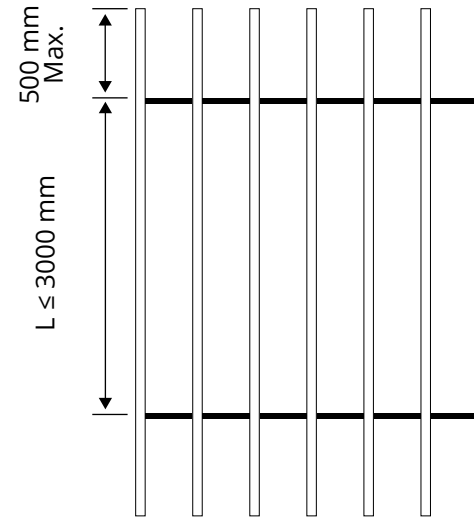

POSE HORIZONTALE

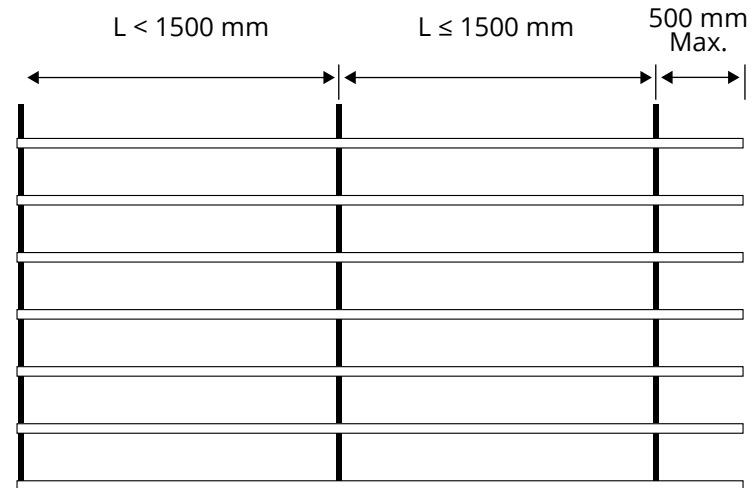

Fiberdeck[®]

fiberdeck.fr