

WEO[®] CO-EXTRUDED COMPOSITE CLADDING





Guaranteed against staining and fading

With years of experience and several million square metres marketed to date in a wide range of climates, we can guarantee our products for 20 years without any visible fading.



Unique decors and striking colours

Our co-extruded boards provide a unique experience. Their outstanding technical and aesthetic properties insure complete peace of mind for the end user.

The boards feature a matt aspect, with intense and multi-chromatic colours. Each board is unique, as the manufacturing process allows for a wide range of random shades. Thus all installed projects blend harmoniously into their environment.



WEO®

Fiberdeck®

Biosourced cladding with unrivalled performance

WEO® cladding boards have been developed using the latest co-extrusion technologies to guarantee a fading-free product for 20 years while using 95% waste in its manufacture! A waterproof polyethylene film protects the wood from moisture absorption and stabilises the material. Furthermore, expansion is reduced to a minimum.



The mark of responsible forestry

WEO[®] Classic



A CLADDING BOARD WITH INTENSE AND BRIGHT COLOURS !

WEO[®] Classic cladding boards are available in 4 multi-coloured shades that are guaranteed against fading. They confer a unique shine to your facade. The very durable brushed and matt surface beautifully imitates natural wood !



WEO® CLASSIC CLADDING BOARD
13 x 173 mm x 3.6 m



Teak
FD1082



Ipe
FD1083



Light Grey
FD1084



Dark Grey
FD1085

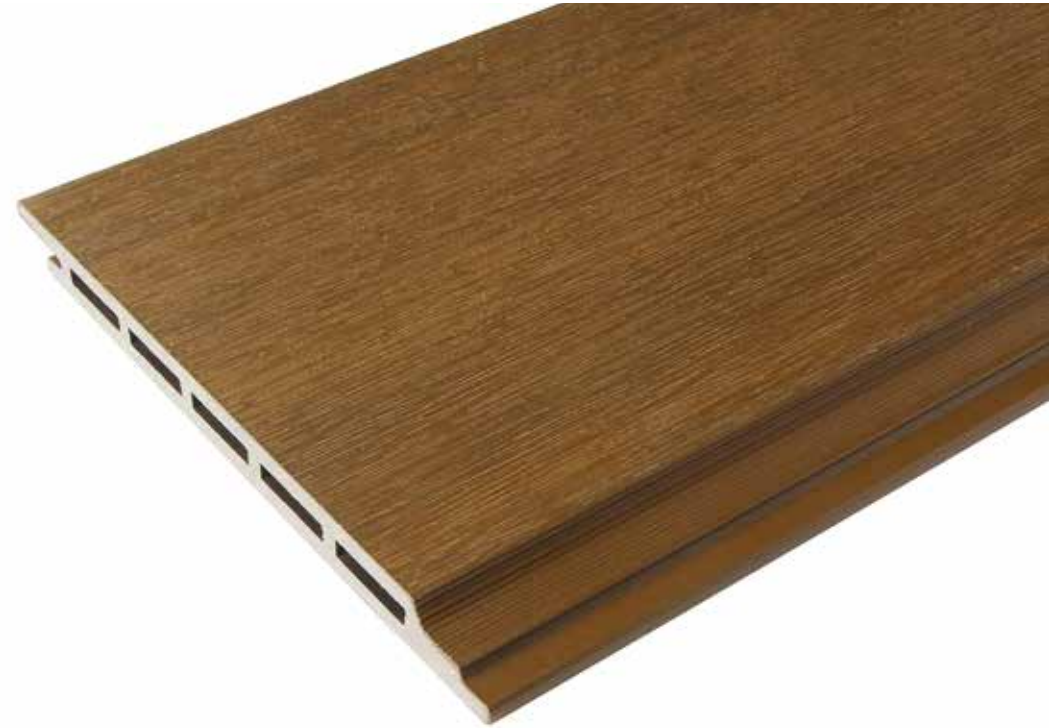

ALUMINIUM U STARTING PROFILE (2 PCS)

25 x 0,7 mm x 3 m
FD1090



ALUMINIUM F PROFILE

35 x 45 mm x 3,60 m

FD1086 | ■ Teak
FD1087 | ■ Ipe

FD1088 | ■ Light Grey
FD1089 | ■ Dark Grey



WEO® CLASSIC STAINLESS STEEL CLIP
(100 PCS) + SCREW

9 m²
FD1091



WEO® CLASSIC STAINLESS STEEL SCREWS
(100 PCS)

For vertical installation | 20 m²

FD1313 | ■ Teak
FD1314 | ■ Ipe

FD1315 | ■ Light Grey
FD1316 | ■ Dark Grey

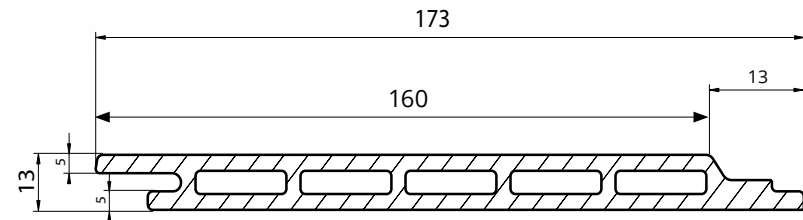

Usable surface per board	0,5832 m ²
Mass per unit area	10,3 kg/m ²
Outer width	173 mm
Usable width	162 mm
Standard length	3600 mm

WEO[®] 35

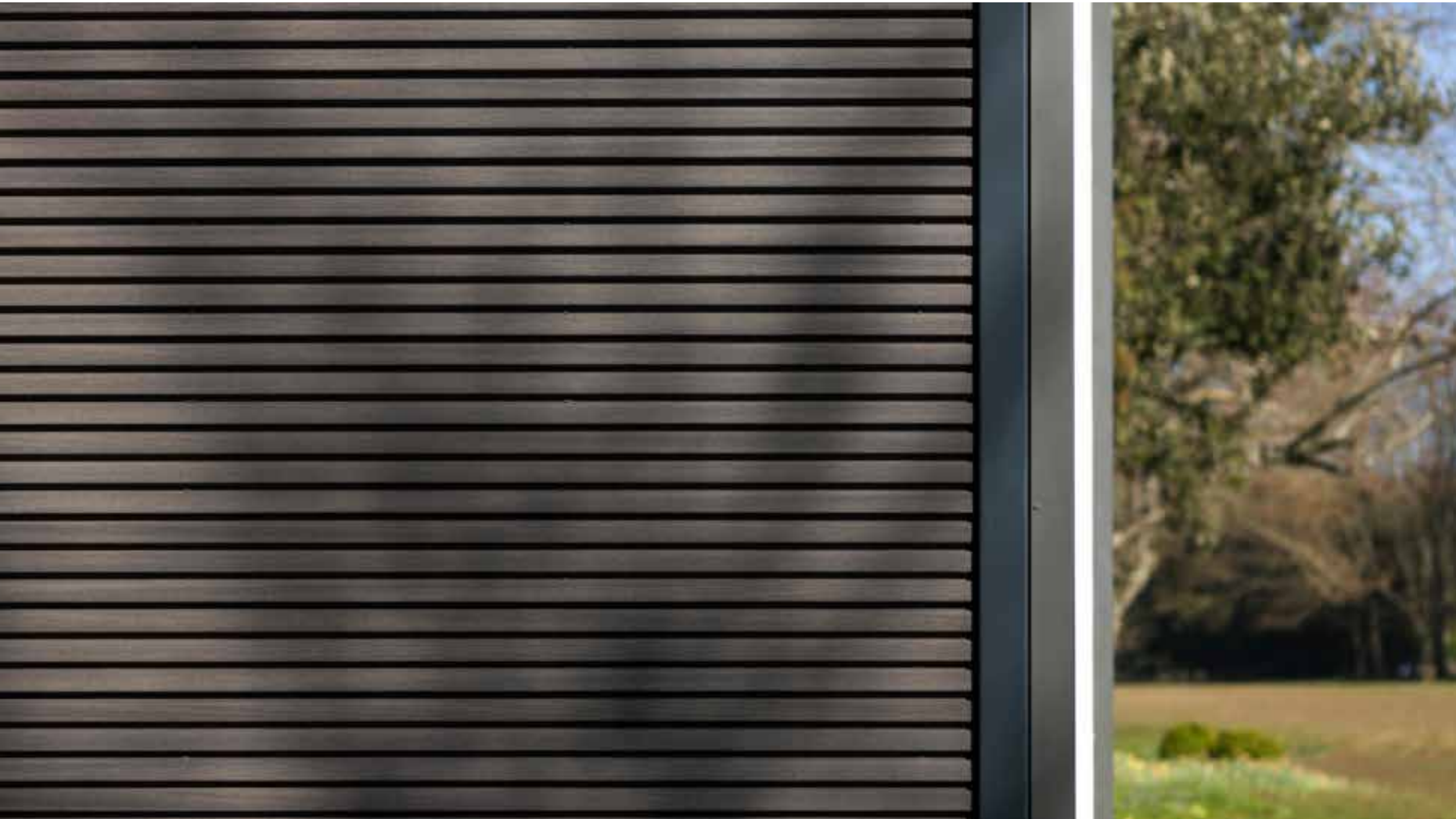

A CONTEMPORARY SLATTED DECOR

WEO[®] 35 slatted boards offer unparalleled durability. They give your facade a chic, modern look in matt wood colours without any fading or maintenance.



WEO® 35 CLADDING BOARD

33 x 170 mm x 2.9 m | 33 x 170 mm x 3.9 m



NEW



Cedar
2.9 m FD1544
3.9 m FD1548



Teak
2.9 m FD1541
3.9 m FD1545



Ipe
2.9 m FD1542
3.9 m FD1546



Dark Grey
2.9 m FD1543
3.9 m FD1547



ALUMINIUM F PROFILE

65 x 80 mm x 3,60 m

- FD1428 | Cedar
- FD0967 | Teak
- FD0968 | Ipe
- FD0970 | Dark Grey



STAINLESS STEEL SR2 SCREW (BOX OF 100 PCS) + END CAPS

4,2 x 38 mm | 6 m²

- FD1451 | Cedar
- FD1447 | Teak
- FD1448 | Ipe
- FD1450 | Dark Grey

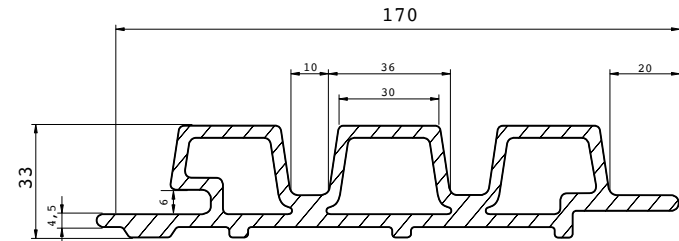

	Length 2.9 m	Length 3.9 m
Usable surface per board	0,406 m²	0,546 m²
Mass per unit area	15 kg/m²	15 kg/m²
Outer width	170 mm	170 mm
Usable width	140 mm	140 mm

WEO® 60



A MODERN SLATTED DECOR

WEO® 60 cladding boards feature a slatted design and can be installed quickly horizontally or vertically. The 60mm-wide boards are evenly spaced 10mm apart. They are lightweight, stable and easy to install with our mounting system. These boards can also be combined with WEO® 35 and WEO® 60 profiles to create more variations, or paired with any other modern material.



WEO® 60 CLADDING BOARD

33 x 170 mm x 2.9 m | 33 x 170 mm x 3.9 m



Cedar
2.9 m FD1567
3.9 m FD1571



Teak
2.9 m FD1565
3.9 m FD1569



Ipe
2.9 m FD1566
3.9 m FD1570



Dark Grey
2.9 m FD1568
3.9 m FD1572



ALUMINIUM F PROFILE

65 x 80 mm x 3,60 m

- FD1428 | Cedar
- FD0967 | Teak
- FD0968 | Ipe
- FD0970 | Dark Grey

STAINLESS STEEL SR2 SCREW (BOX OF 100 PCS) + END CAPS

4,2 x 38 mm | 6 m²

- FD1451 | Cedar
- FD1447 | Teak
- FD1448 | Ipe
- FD1450 | Dark Grey



WEO® 60 STAINLESS STEEL SCREWS FOR CONCEALED INSTALLATION

4.2 x 32 mm | 500 pcs + end caps

FD1337

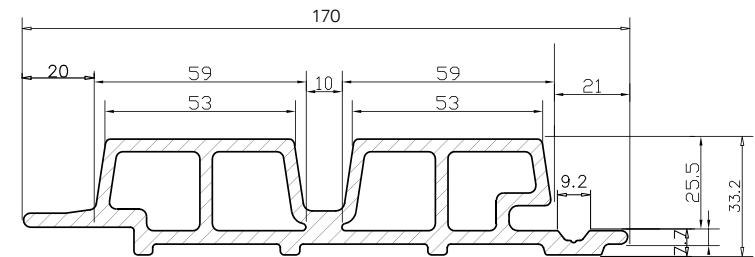

	Length 2.9M	Length 3.9M
Usable surface per board	0,406 m²	0,546 m²
Mass per unit area	14,5 kg/m²	14,5 kg/m²
Outer width	170 mm	170 mm
Usable width	140 mm	140 mm

WEO[®] Brise-soleil



A SET OF WOODEN BOARDS FOR PROTECTION FROM THE SUN !

These composite wood sunshades offer effective protection from the sun. By adjusting the spacing between the boards, they allow shadows to play on the facade and provide excellent heat insulation. A unique and contemporary wood decor that does not age

Fiberdeck®



Teak



Ipe



BRISE-SOLEIL BOARD	Teak	Ipe
42 x 60 mm x 4 m	FD1092	FD1093
52 x 100 mm x 4 m	FD1094	FD1095
62 x 120 mm x 4 m	FD1096	FD1097



END CAP	Teak	Ipe
42 x 60 mm (x24)	FD1098	FD1099
52 x 100 mm (x10)	FD1100	FD1101
62 x 120 mm (x6)	FD1102	FD1103



1 ALUMINUM STAPLE - NV3 Adjustable
FD1154



2 CROSSBAR KX-3000 RAL9005
FD1156



3 WEDGE - Thermal break pad
FD1157



4 A2 STAINLESS STEEL SCREW - self-drilling
5,5 x 32 mm FD1155 5,5 x 50 mm FD1223
5,5 x 38 mm FD1222 5,5 x 60 mm FD1224

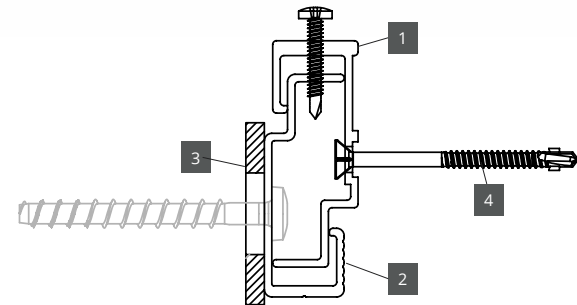

WEO[®] Classic

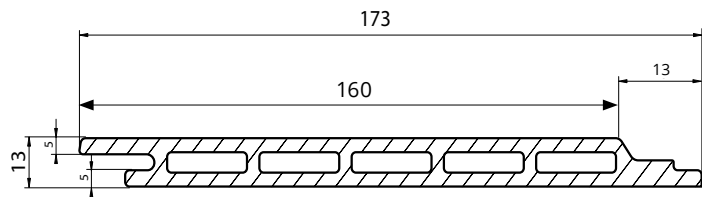

Usable surface per board	0,5832 m ²	
Mass per unit area	10,3 kg/m ²	
Outer width	173 mm	
Useful width	162 mm	
Standard length	3600 mm	
	Qty of clips / m ²	Qty of clips / board of 3.6 m
Span 600 mm	11	7

WEO[®] 35

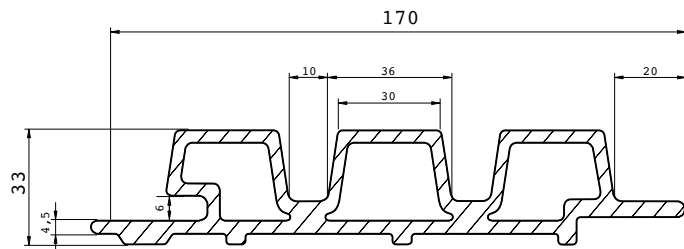

Standard length	2900 mm	3900 mm
Usable surface per board	0,406 m ²	0,546 m ²
Mass per unit area	15 kg/m ²	15 kg/m ²
Outer width	170 mm	170 mm
Useful width	140 mm	140 mm
Qty of screws / m ² (600mm span)	12	12
Qty of screws / board (600 mm span)	5	7

WEO[®] 60

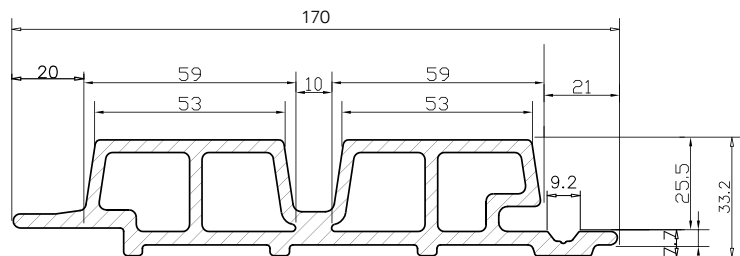

Standard length	2900 mm	3900 mm
Usable surface per board	0,406 m ²	0,546 m ²
Mass per unit area	14,5 kg/m ²	14,5 kg/m ²
Outer width	170 mm	170 mm
Useful width	140 mm	140 mm
Qty of screws / m ² (600 mm span)	12	12
Qty of screws / board (600 mm span)	5	7

WEO[®] Brise-Soleil

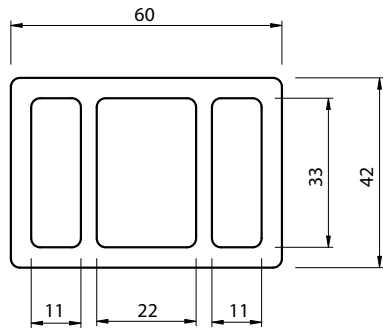

Weight / Linear metre	1,75 kg
Outer width	60 mm
Outer height	42 mm
Standard length	4 m

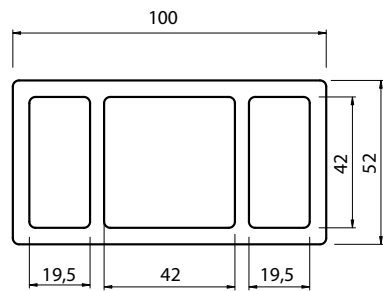

Weight / Linear metre	3 kg
Outer width	100 mm
Outer height	52 mm
Standard length	4 m

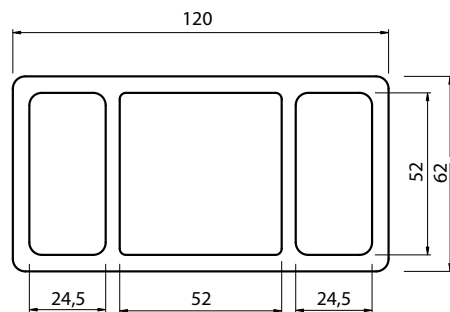

Weight / Linear metre	3,70 kg
Outer width	120 mm
Outer height	62 mm
Standard length	4 m

WEO[®] Classic

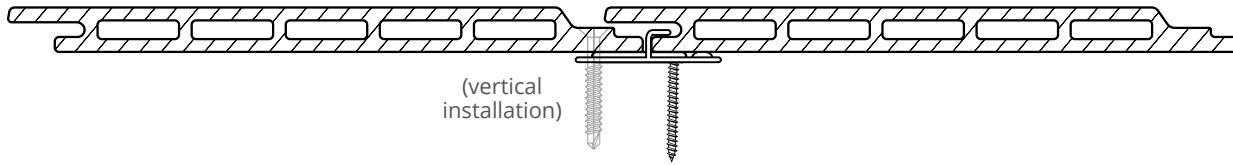

CLIP FASTENING

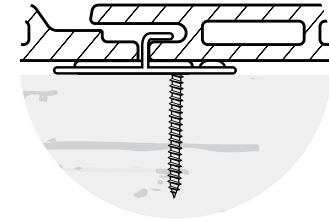

WEO[®] 35

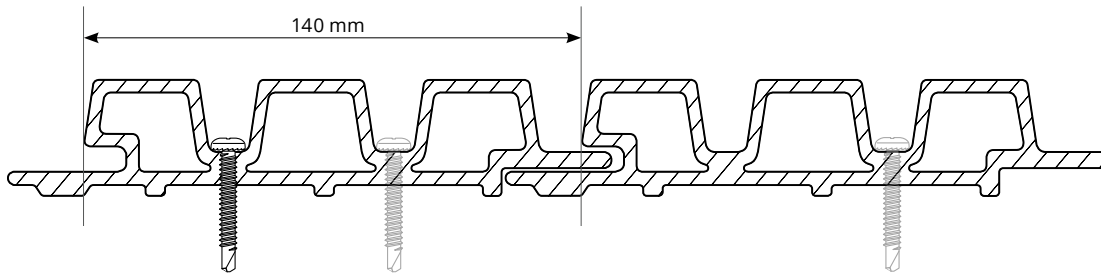

SCREW FASTENING

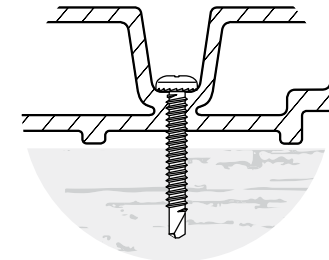

WEO[®] 60

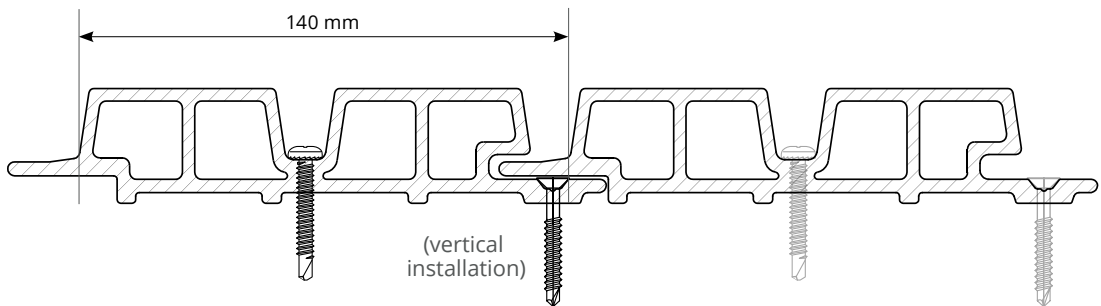

SCREW FASTENING

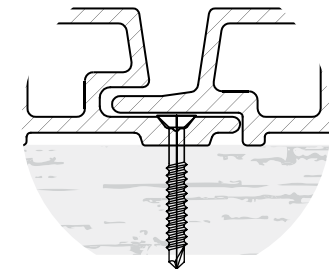

WEO[®] Brise-Soleil

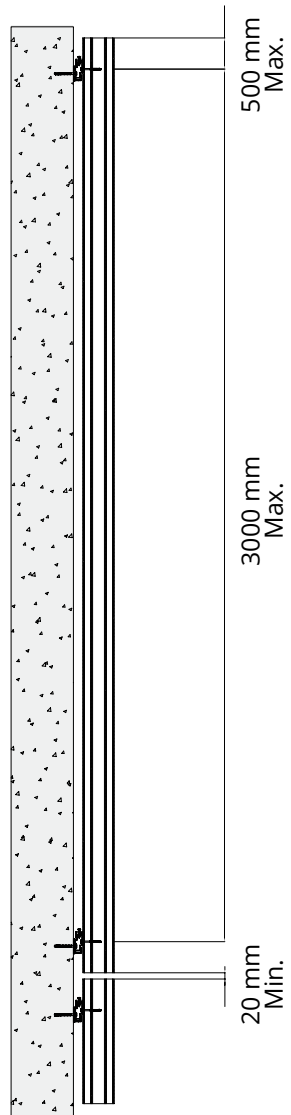

STAPLE FIXING ON CROSSBAR

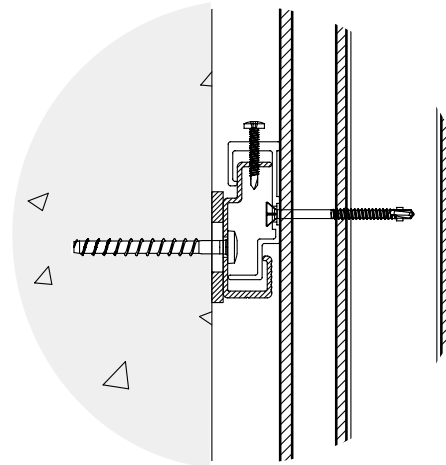

VERTICAL INSTALLATION

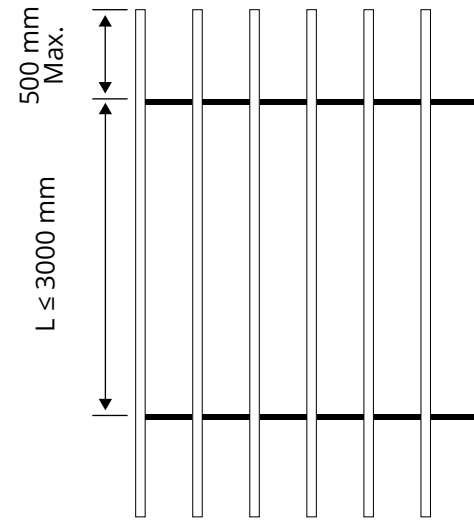

HORIZONTAL INSTALLATION

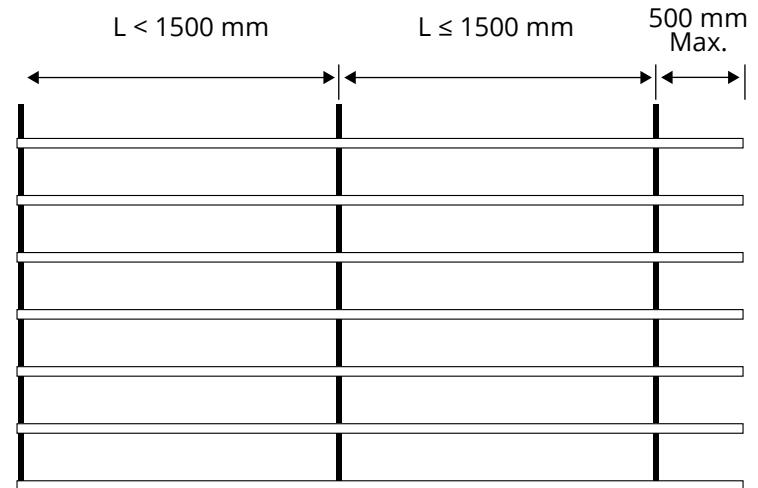

Fiberdeck[®]

fiberdeck.com